

# The Original.

Often Imitated,  
Never Surpassed.

The American Made Push and Squeeze Tube Utility Grease Guns remain the only fully rebuild-able guns in their classes. Requiring only one hand to operate, they are ideal for working in confined areas where lever-action guns are cumbersome and inconvenient. All models will handle multi-viscous grades of lubricant.

• For Squeeze Tube Guns; See page 3.



All Nozzle Types and Plunger Assemblies are interchangeable between Push and Squeeze Tube Models. All Parts are replaceable.

## Push & Squeeze Tube Features:

- Lightweight, compact & easy to use
- Durable all metal construction
- Self activated priming
- Quick service and cleaning
- All parts serviceable & replaceable
- Ground plunger
- Ball check
- Pinpoint accuracy
- Easy to refill

## Push & Squeeze Tube Applications:

- Air Tools • Aircraft • Bicycles
- Motorcycles • Wheel Bearings
- Appliances • Fishing Reels
- Marine Engines • Golf Carts
- Garden Equipment • Sewing Machines
- Elevators • Power Tools
- Chainsaws • Automotive
- Bearings • Tractors
- Lawn Mowers • Industrial Machinery
- Office Equipment
- Locomotive • Firearms
- Door Hinges • Equine Services
- Industrial Sweepers
- Specialty Equipment
- And Much More

## NEW! Cartridge Utility Gun

Designed for your Favorite  
Standard 3oz Cartridges.



## Popular Push Type Specifications

Model	Priming Type	Capacity	Nozzle Extension	Net Weight
5968A <b>NEW!</b>	Spring	3 oz Cartridge	10503 Hardened Tip for all flush type grease fittings *	16.0 oz.
5962	Spring	3 oz	10548 Hydraulic Coupler • 3-Jaw with Built-in Ball Check	13.0 oz.
700231	Vacuum	3 oz	10503 Hardened Tip for all flush type grease fittings *	9.0 oz.
10590	Vacuum	3 oz	Quick Connect with Zerk Refill Port (See Page 4 for Attachments)	13.0 oz.

All Nozzles are replaceable. All Dualco products are highly modular in design, making it easy to precisely create the lubrication tools you need. Many other gun & accessory combinations are available.

\* Needle Nozzle Port Diameter = 0.031" (1/32")





Specifications

Model	Priming Type	Capacity	Nozzle Extension	Net Weight
5948A	Spring	3 oz.	10503 Hardened Tip for all flush type grease fittings *	11.0 oz.
5911	Vacuum	3 oz.	10530 2.5" Long for Standard Hydraulic Grease Fittings	10.0 oz.
5914	Spring	3 oz.	10549 12" Flexible Hose with 10548 Hydraulic Coupler	15.0 oz.

\* Needle Nozzle Port Diameter = 0.031" (1/32")



Specifications

Model	Priming Type	Capacity	Nozzle Extension	Net Weight
5947	Spring	3 oz.	10530 2.5" Long for Standard Hydraulic Grease Fittings	12.0 oz.
5948	Spring	3 oz.	10535 4" Long for Standard Hydraulic Grease Fittings	13.0 oz.
5958	Spring	5 oz.	10535 4" Long for Standard Hydraulic Grease Fittings	16.0 oz.

Check out our extensive selection of Accessories and Tips for more options.



Custom Colors  
Ask about our custom Powder-Coating and Plating.



# Squeeze Tube

Squeeze Tube Guns are perfect for one hand operation in tight spaces. These models are designed to be used with squeeze tube containers. Simply squeeze the tube to prime. All models will handle multi-viscous grades of lubricant.



All Nozzle Types and Plunger Assemblies are interchangeable between Push and Squeeze Tube Models. All Parts are replaceable.

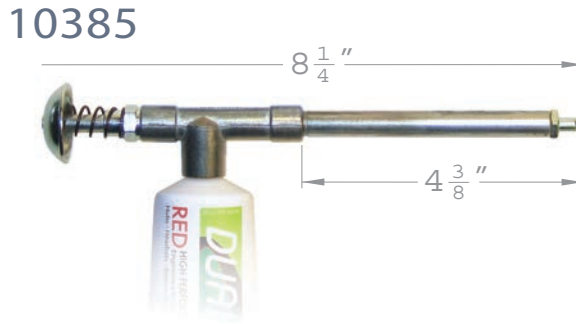
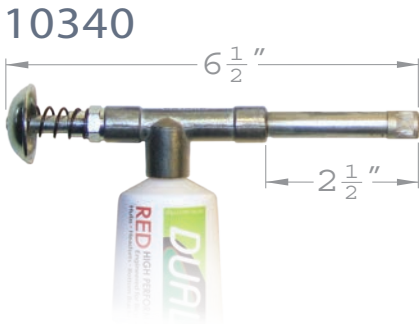

## Specifications

Model	Nozzle Extension	Net Weight
10350	10503 Hardened Tip for all flush type grease fittings *	3.0 oz.
10375	10586 2-3/8" long Narrow Hardened Tip for all flush type grease fittings *	3.8 oz.
10360	10547 4-1/2" long Narrow Stainless Tip for all flush type grease fittings *	3.5 oz.
10355	10546 2-1/4" long Narrow Stainless Tip for all flush type grease *	3.3 oz.
10340	10530 10530 2-1/2" Long for Standard Hydraulic Grease Fittings	4.0 oz.
10385	10583 4-1/4" Long with Replaceable Hardened Tip for all flush type grease *	4.5 oz.

\* Needle Nozzle Port Diameter = 0.031" (1/32")

■ All DUALCO Squeeze Tube guns accept tubes with 9/16-18 threads. All of our products are highly modular in design, making it easy to precisely create the lubrication tools you need.





# Accessories & Tips

These are our many options for Push Type Utility & Squeeze Tube grease guns.

All of these accessories are designed to work with both Push Type Utility and Squeeze Tube grease guns. Our products are highly modular in design, making it easy to precisely create the lubrication tools you need. Many other accessories and fittings are available.

## Standard

Model	Description	Length	Connection
10503	Hardened Tip Nozzle for all flush type fittings. • Replacement for all Push & Squeeze tube guns & accessories using 1/8" NPT thread.*	0.81"	1/8" NPT thread
10569	Needle Nozzle for all flush type fittings - Female thread *	1.00"	1/8" NPT thread
10546	Narrow Stainless Tip for all flush type grease fittings or hard to reach places *	2.25"	1/8" NPT thread
10547	Narrow Stainless Tip for all flush type grease fittings or hard to reach places *	4.50"	1/8" NPT thread
10555	Hardened Needle Tip Nozzle for all flush type grease fittings *	12.0"	1/8" NPT thread
10581	Hardened Needle Tip Nozzle for all flush type grease fittings *	0.81"	1/4-28 thread
10586	Nozzle Extension Assembly for all flush type fittings *	2.50"	1/8" NPT thread
10583	Nozzle Extension Assembly for all flush type fittings *	4.50"	1/8" NPT thread
10530	Extension Assembly for standard hydraulic type fittings	2.50"	1/8" NPT thread
10535	Extension Assembly for standard hydraulic type fittings	4.50"	1/8" NPT thread

\* Needle Nozzle Port Diameter = 0.031" (1/32")

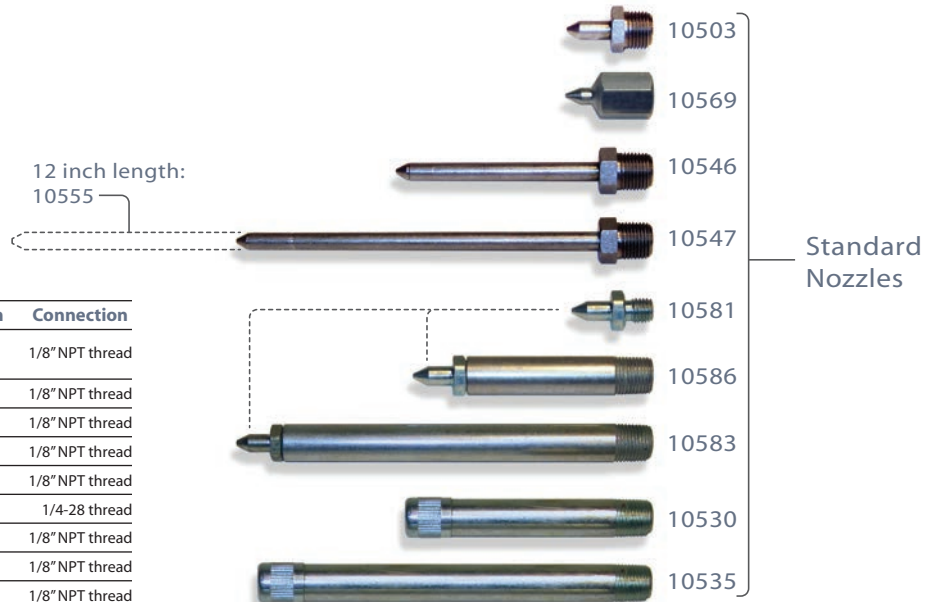

## Quick Connect

Model	Description	Length	Connection
11049	Quick Connect Adapter Fitting	1.50"	1/8" NPT thread
10120	Hydraulic Coupler with 3 Jaw built-in ball check outlet	2.38"	Quick Connect
10130	Rubber Tipped Nozzle on Stainless Fitting ‡	3.50"	Quick Connect
10140	Narrow Stainless Tip for all flush type grease fittings or hard to reach places *	5.50"	Quick Connect
11047	Quick Connect Male Nipple (plug)	1.13"	1/8" NPT thread
11048	Quick Connect Female Nipple (plug)	1.25"	1/8" NPT thread

Featuring fast switching between tips, the 10590 is the most adaptable Utility guns available. Dualco Quick Connect fitting can be used on any Dualco Push Type or Squeeze Tube grease guns.

‡ Rubber Tipped Port Diameter = 0.110" (7/64")  
 \* Needle Nozzle Port Diameter = 0.031" (1/32")



10590  
Quick Connect with Zerk Refill Port

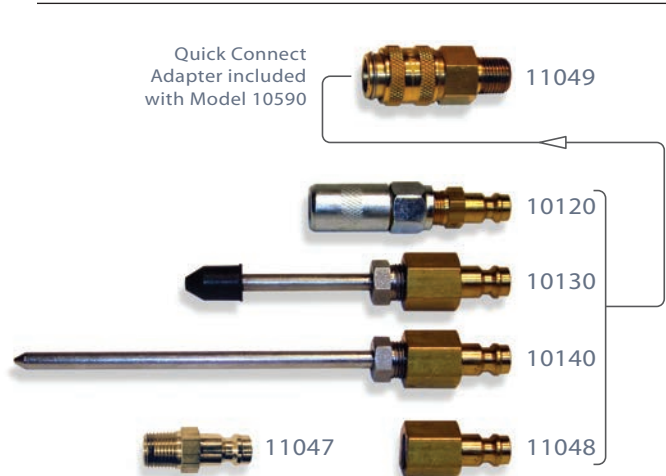





## Stub-Nose

Model	Description	Length	Connection
10544	Rubber Tipped Nozzle on Stainless Fitting ‡	4.75"	1/8" NPT thread
10542	Rubber Tipped Nozzle on Stainless Fitting ‡	3.75"	1/8" NPT thread
10540	Rubber Tipped Nozzle on Stainless Fitting ‡	2.56"	1/8" NPT thread
10587	Rubber Tipped Nozzle on Stainless Fitting • Female Thread ‡	1.44"	1/8" NPT thread
10537	Replacement Rubber Nozzle Tip • 1/16" outlet diameter	0.63"	Friction Fit
10539	Stub-Nose Stainless Nozzle*	2.25"	1/8" NPT thread
10541	Stub-Nose Stainless Nozzle*	3.50"	1/8" NPT thread
10543	Stub-Nose Stainless Nozzle*	4.50"	1/8" NPT thread
10576	Stub-Nose Stainless Nozzle • Female Thread*	1.34"	1/8" NPT thread

‡ Rubber Tipped Port Diameter = 0.110" (7/64")  
 \* Stub Nose Port Diameter = 0.110" (7/64")

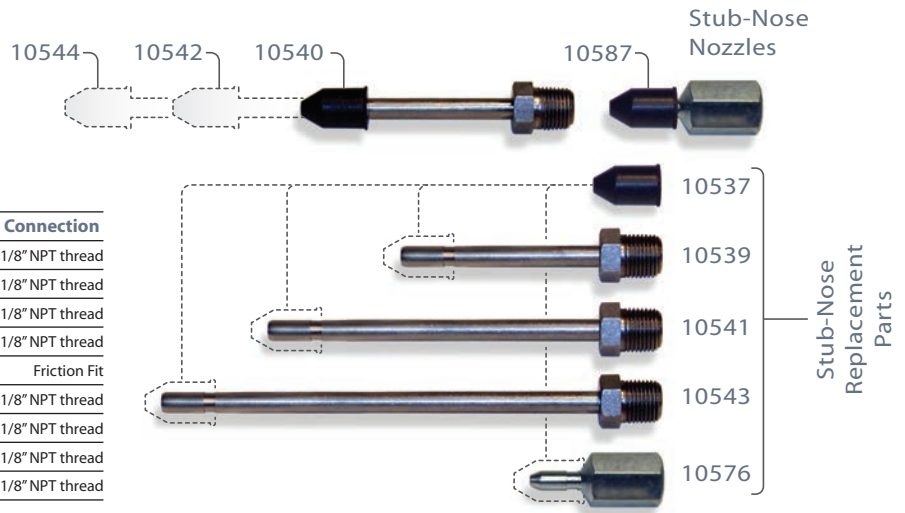

## Extensions & Adapters

Model	Description	Length	Connection
10548	Hydraulic Coupler • 3-Jaw with Built-in Ball Check • 5,000 psi Rated	1.44"	1/8" NPT thread
10574	Nozzle Adapter for Hydraulic Couplers • For All Flush Type Grease Fittings *	0.84"	Hydraulic Snap-on
10588	Needle/Hydraulic Coupler Nozzle Combo • 10574 + 10548	2.00"	1/8" NPT thread
10551	Pipe Nipple Male • Use to Assemble 10588 & Other Accessories	0.75"	1/8" NPT thread
10553	Pipe Nipple Male • Use to Assemble 10588 & Other Accessories	3.00"	1/8" NPT thread
10549	Flexible Extension Hose for Hard to Reach Areas • 2,500 psi Max.	12.0"	1/8" NPT thread
10532	Pipe Coupling with Hex • Female both Ends	~	1/8" NPT thread

\* Needle Nozzle Port Diameter = 0.031" (1/32")

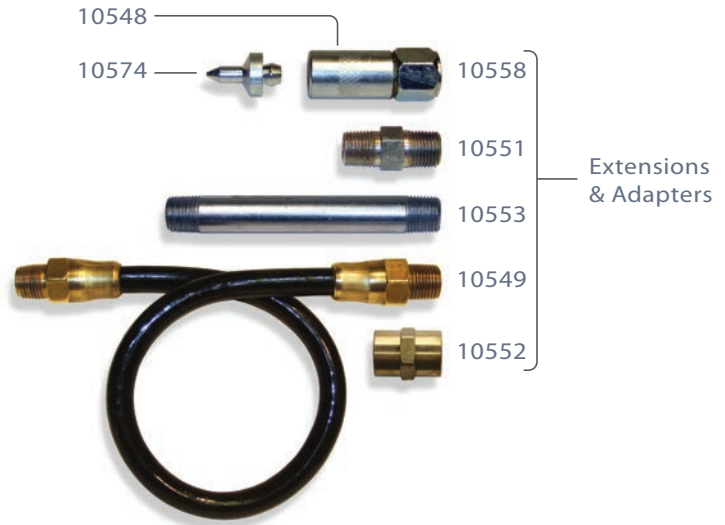

## Aircraft & Specialty

Model	Description	Length	Connection
10060	Grease Injector Needle • 18 v	2.44"	Hydraulic Snap-on
10080	90° Adjustable Nozzle for Aircraft & Hard to Reach Areas *	3.0"	1/8" NPT thread
10560	90° Adjustable Nozzle for Aircraft & Hard to Reach Areas *	6.0"	1/8" NPT thread
10565	90° Adjustable Nozzle for Aircraft & Hard to Reach Areas *	12.0"	1/8" NPT thread
10090	Reverse Inclined 45° Adjustable Nozzle for Aircraft & Hard to Reach Areas *	3.0"	1/8" NPT thread
10570	Reverse Inclined 45° Adjustable Nozzle for Aircraft & Hard to Reach Areas *	6.0"	1/8" NPT thread
10575	Reverse Inclined 45° Adjustable Nozzle for Aircraft & Hard to Reach Areas *	12.0"	1/8" NPT thread

\* Nozzle Port Diameter = 0.031" (1/32")

■ Many other accessories and fittings are available. Please Contact Us for specific needs. We Specialize in Custom Solutions, and would love to hear about your requirements.

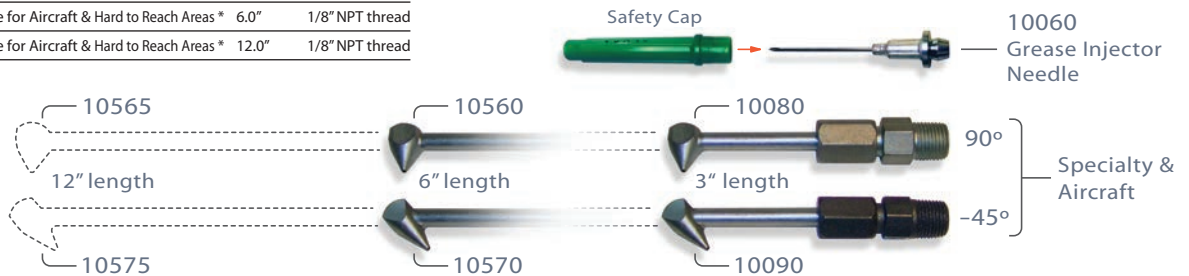

Producing Professional lubrication products since 1960. Products are made and assembled in the USA. 100% Repairable and Recyclable.



8404 Braniff  
 Houston, Texas 77061  
 713-644-1164 • FAX 713-644-7761  
 www.dualco-inc.com